



ENVIROGRAF®



FIRE BARRIER & CAVITY SYSTEMS STOP **KILLER** FIRES!

Products 54, 55, 56, 57, 117, & 125 Data Sheet



Peterborough Greyhound Stadium was saved from disaster by Envirograf® Fire Barrier Curtain fitted to the right-hand section

BARRIER CURTAIN AND CAVITY PROTECTION SYSTEMS TO STOP THE SPREAD OF FIRE AND SMOKE



**PROTECTING PROPERTY
PROTECTING LIVES**



COPYRIGHT © 2008 INTUMESCENT SYSTEMS LTD

Intumescent Systems Ltd, Envirograf House, Barfrestone, Dover, Kent, CT15 7JG, United Kingdom

Phone: +44 (0) 1 304 842 555 – Fax: +44 (0) 1 304 842 666 – Email: sales@envirograf.com – URL: www.envirograf.com

INTRODUCTION

Concealed cavities in buildings offer a quick path for fire and smoke. These areas are often ignored because they are out of sight, and this leaves enormous openings in the fire barrier structure of a building, making compartments vulnerable and rendering the escape routes ineffective. UK Building Regulations give clear instructions regarding the specifications for fire barriers. Envirograf® fire barrier products have been designed to fulfill the requirements of these regulations.

ADVANTAGES

- A complete range of intumescent fire/smoke barriers
- Suitable for most flexible barrier installations
- Straightforward application
- Environmentally-friendly
- Cost-effective
- Overlaps joined with Envirograf® intumescent adhesive
- Services passing through the barrier can be easily protected



PRODUCT 54 – INSULATED FIRE BARRIER

PRODUCT APPLICATION

An insulated fire barrier, easily shaped, folded, or cut to size. Used for fixing to timber/steel trusses, or between concrete soffits and suspended ceilings, etc. It fits easily around services or into awkward corners, and can be used to wrap around metal trunking to upgrade protection. Supplied with metal fixing straps for concrete or brick, or fibre battens for fixing to timber.

PERFORMANCE

1 hr version achieved 77 mins integrity/insulation at TRADA UK. 2 hr version achieved 2 hrs 12 mins integrity and 44 mins insulation (furnace was switched off, but product could have survived longer) in recent BTC UK test to BS476 Part 22 (1987). Previously, a single layer of the fire barrier used in this product was tested to BS476 Part 22 (1987), achieving 87 mins integrity and 20 mins insulation.

ORDERING REFERENCES

Ref	Ref	Type of fixing required
IFB1	1 hr rated insulated fire barrier	Steel or concrete fixing
IFB2	2 hr rated insulated fire barrier	Timber fixing
		Duct fixing



PRODUCT 55 – CAVITY WALL BARRIER & VENTILATED CAVITY WALL BARRIER

PRODUCT APPLICATION

A 5mm thick, foil-clad intumescent (WB) plus a new ventilated type (VWB) which allows moisture to disperse, in various widths and up to 20 metres in length. Used on both the vertical and horizontal faces around window frames and door frames, fixed with staples or large-headed nails. The ventilated version allows moisture to disperse, without detriment to its fire-sealing ability. Ideal for use behind UPVC windows and timber-framed houses as both horizontal and vertical barriers.

PERFORMANCE

This product has been subjected to a fire test in accordance with BS476 Part 22 (1987), achieving 90 minutes integrity and 22 minutes insulation.

ORDERING REFERENCES

Ref	State width and length
WB	State width and length
VWB	State width and length (widths to suit various cavities)



PRODUCT 56 – FB30 FIRE BARRIER CURTAIN

PRODUCT APPLICATION

1½mm thick reinforced glass cloth with red Envirograf® intumescent coating, available in 1220mm width and any length (FB30). A water-resistant version is available (FB30/W). Also available is an acoustic protection version in 16½mm thickness and 1220mm width (FB30/AC). The product is fixed to timber or steel trusses, or between concrete soffits and suspended ceilings etc. Overlap joints by 50mm and fasten with supplied adhesive. FB30 can have doors and openings fitted.

PERFORMANCE

Tested to BS476 Part 22 (1987), achieving 36 mins integrity. Indicative test showed 15 mins insulation. Tested over Class 0 suspended ceiling horizontally, 22 mins insulation to BS476 Part 22 (1987). In a fire at Peterborough Greyhound Stadium, England, barrier saved half stadium building in 6 hour fire.



ORDERING REFERENCES

FB30 1220mm wide – state length required
FB30/W Water-resistant version of FB30
FB30/AC Available in 1220mm width only – state length

PRODUCT 57 – FB70 FIRE BARRIER CURTAIN

PRODUCT APPLICATION

1½mm thick reinforced glass cloth with red Envirograf® intumescent coating, available in 1220mm width and any length (FB70). A water-resistant version is available (FB70/W). Also available is an acoustic protection version in 16½mm thickness and 1220mm width (FB70/AC). The product is fixed to timber or steel trusses, or between concrete soffits and suspended ceilings etc. Overlap joints by 50mm and fasten with supplied adhesive. FB70 can have doors and openings fitted.

PERFORMANCE

This product has been tested in accordance with BS476 Part 22 (1987), achieving an 81 minutes integrity and 18 minutes insulation.

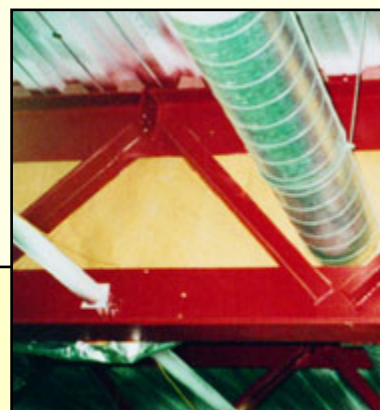

ORDERING REFERENCES

FB70 1220mm wide – state length required
FB70/W Water-resistant version of FB70
FB70/AC Available in 1220mm width – state length required

PRODUCT 117 – SMOKE CURTAIN

PRODUCT APPLICATION

This is an intumescent-coated glass cloth that will withstand temperatures of up to 1200°C, providing smoke protection and BS476 Class 0 and Class 1 protection. Supplied in 1000mm and 1200mm widths. Envirograf® smoke curtain is a very robust, hard-wearing material. Envirograf® Product 117 can also be supplied as a rolled curtain unit supported by an electric motor. When activated, the curtain will drop and (if required) it can be rolled back by electric motor and switch. The curtain can be cut with a sharp knife or scissors, and adhesive is supplied for a 25mm to 30mm joint to be made, allowing the curtain to be made up to any size required. When fixing the curtain to steel or concrete, use Envirograf® FB/C metal straps, and for fixing to timber, use Envirograf® FB/T battens.

PERFORMANCE

Suitable for shopping malls and other large areas that need smoke protection and/or BS476 Class 0/Class 1 spread of flame protection.

ORDERING REFERENCES

Ref
SC State width and length required
 Metal hangers and weights can be supplied



PRODUCT 125 – FIRE BARRIER CURTAIN FOR ROOF VOIDS

PRODUCT APPLICATION

This is a fire barrier curtain for use where insulation is not an important criterion. Available in 1200mm widths. For separation in lofts and suspended ceiling areas. All joints must be overlapped by 50mm and adhered with Envirograf® Product 57 fireproof adhesive. Services can penetrate the barrier.

PERFORMANCE

This product has been subjected to a fire test in accordance with BS476 Part 22 (1987), achieving 39 minutes integrity and 3 minutes insulation.

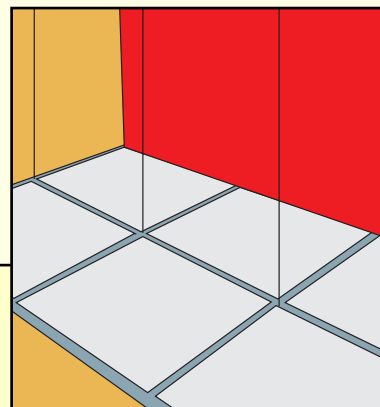

ORDERING REFERENCES

Ref **Width**
VB3012 1200mm

FIXING INSTRUCTION – PITCHED ROOF

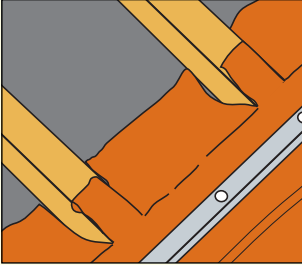

When the barrier overlaps the battens, it is important to cut the barrier as shown above, tucking it between the battens

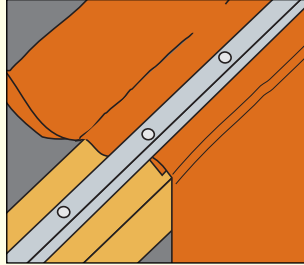

When the barrier overlaps a battenless roof, it is important that the barrier overlap is double-folded under the fire barrier fixing batten

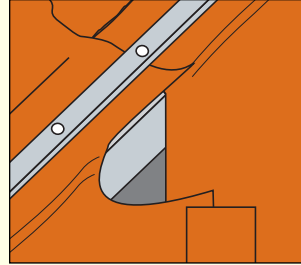

A 50mm overlap must be allowed at joints, for fixing with tape and supplied Envirograf® adhesive. Optional tape available for extra support during setting



FIXING INSTRUCTION – SUSPENDED CEILING

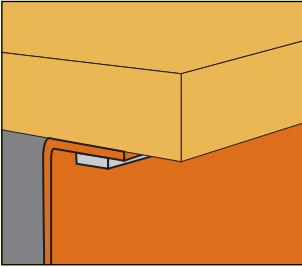

To fix the barrier to the upper roof section, use the metal strap to clamp the barrier and fix with screws or pins

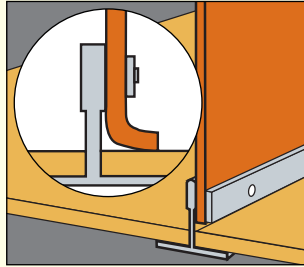

To fix the barrier to suspended ceiling brackets, either use the metal strap and self-tapping screws as shown above left, or the special clips shown above right, spaced at 500mm intervals

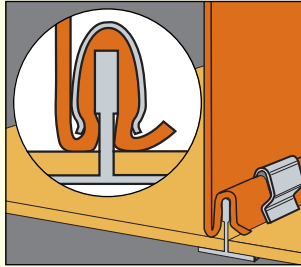

FIXING INSTRUCTION – SERVICE PENETRATIONS

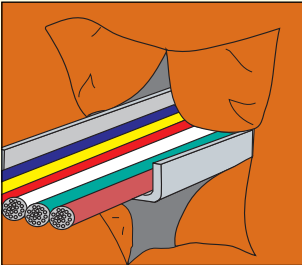

Cut a cross in the barrier to allow the service through

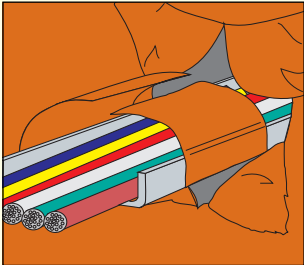

Wrap a 600mm wide barrier strip around the service, allowing 300mm width of cover on both sides of the position where the service penetrates the barrier

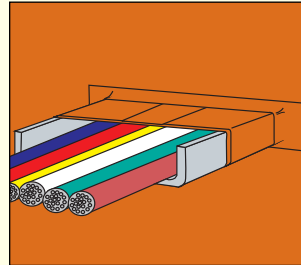

Tidily finish sealing the penetration with Envirograf® adhesive and tape as shown above

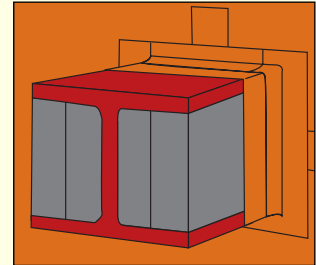

For RSJs and other steel sections, fill out with Envirograf® fireproof sponge as shown above, finishing with Envirograf® adhesive and tape

FIXING INSTRUCTION – DOOR

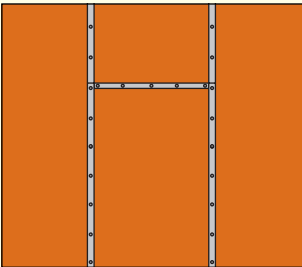

Mark out the door area as shown above and cut the opening edges. Sandwich the hinge side with two pieces of steel strap and rivet the strips together as shown.

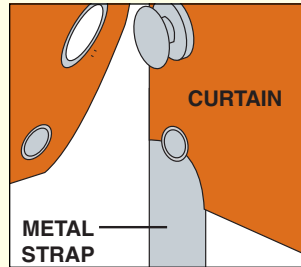
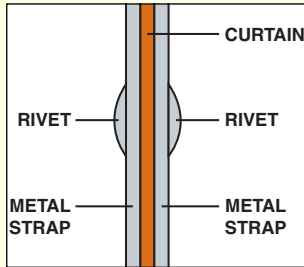

On closing edges of the frame side, rivet one section of steel strap and fix the special turn-button fixings as shown above

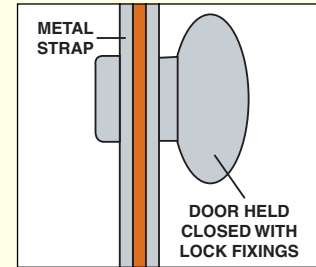

With the door section fixing rings fitted, the door shuts and is locked by turning the turn-button fixings

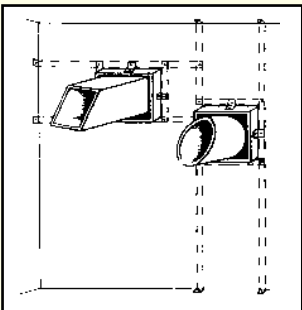

Penetrations through barriers (cable trays, pipes, timber beams, trunking, steel beams, etc) must be wrapped with a 600mm wide strip of the barrier, allowing 300mm width each side of the penetration, overlapping the strip ends by 50mm and adhering with Envirograf® Product 57 (FPA) adhesive. Where services are supported both sides of the barrier, no other protection is needed. If not supported both sides, or for PVC pipes or cables, then either Envirograf® Product 13 (WPCS) or Product 16 (EB) should be used with Product 57 (FB/C metal straps) as indicated in the drawing on the left

REGIONAL OFFICE